

## Certificate of Analysis

**Product Name:** DYKDDDDK tag Peptide

**Cat. No.:** A6002

**Batch No.:** 5

### Physical and Chemical Properties

**Batch Molecular Formula:** C<sub>41</sub>H<sub>60</sub>N<sub>10</sub>O<sub>20</sub>

**Batch Molecular Weight:** 1012.97

**Purity:** >99%

**Cas No.:** 98849-88-8

### Analytical Data

**HPLC:** HPLC

**Mass Spectrum:** Consistent with structure

### Structure

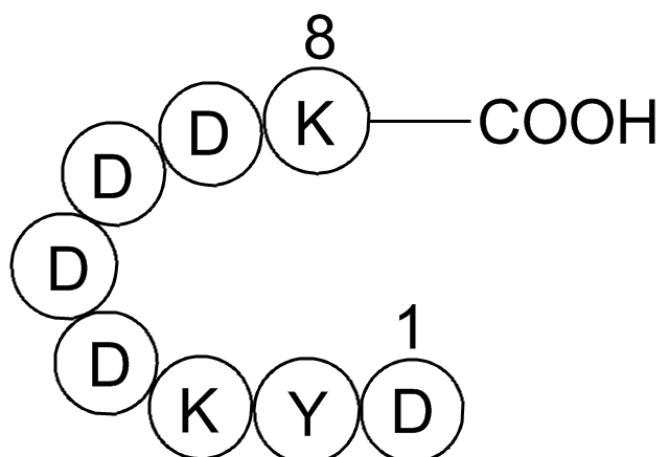

Caution

**FOR RESEARCH PURPOSES ONLY.**

**NOT FOR HUMAN, VETERINARY DIAGNOSTIC OR THERAPEUTIC USE.**

**APEX BIO Technology**

**[www.apexbt.com](http://www.apexbt.com)**

7505 Fannin Street, Suite 410, Houston, TX 77054.

Tel: +1-832-696-8203 | Fax: +1-832-641-3177 | Email: [info@apexbt.com](mailto:info@apexbt.com)