

Certificate of Analysis

Product Name: DYKDDDDK tag Peptide

Cat. No.: A6002

Batch No.: 4

Physical and Chemical Properties

Batch Molecular Formula: C₄₁H₆₀N₁₀O₂₀

Batch Molecular Weight: 1012.97

Purity: >98%

Cas No.: 98849-88-8

Analytical Data

HPLC: HPLC

Mass Spectrum: Consistent with structure

Structure

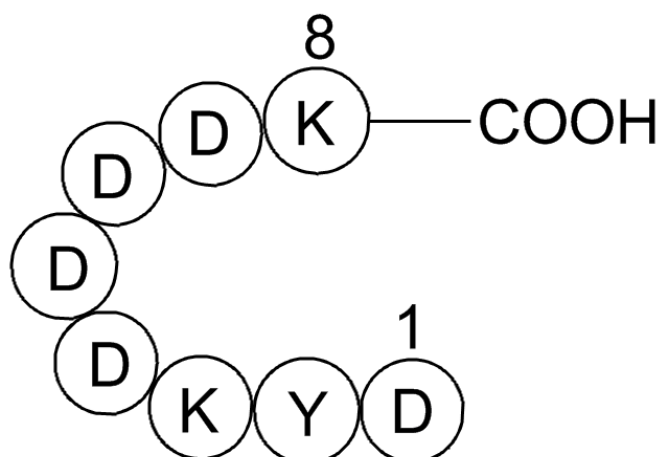

Caution

FOR RESEARCH PURPOSES ONLY.

NOT FOR HUMAN, VETERINARY DIAGNOSTIC OR THERAPEUTIC USE.

APEX BIO Technology

www.apexbt.com

7505 Fannin Street, Suite 410, Houston, TX 77054.

Tel: +1-832-696-8203 | Fax: +1-832-641-3177 | Email: info@apexbt.com