

Certificate of Analysis

Product Name: c-Myc tag Peptide

Cat. No.: A6003

Batch No.: 3

Physical and Chemical Properties

Batch Molecular Formula: C₅₁H₈₆N₁₂O₂₁

Batch Molecular Weight: 1203.3

Purity: >99%

Cas No.:

Analytical Data

HPLC: HPLC

Mass Spectrum: Consistent with structure

Structure

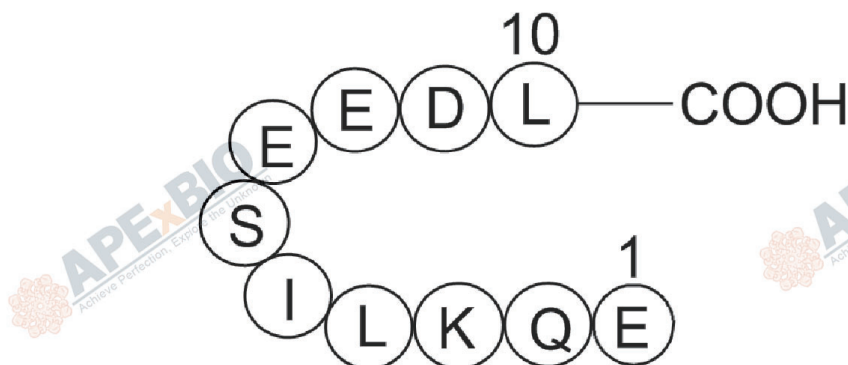

Caution

FOR RESEARCH PURPOSES ONLY.

NOT FOR HUMAN, VETERINARY DIAGNOSTIC OR THERAPEUTIC USE.



APExBIO Technology



www.apexbt.com

7505 Fannin street, Suite 410, Houston, TX 77054.

Tel: +1-832-696-8203 | Fax: +1-832-641-3177 | Email: info@apexbt.com

